

Thank you for purchasing a BN Thermic product. Manufactured to a high standard, this product will, if used according to these instructions and properly maintained, give you years of trouble free performance. Please ensure instructions remain with your customer for their reference.



REGISTER: PLEASE REGISTER THIS PRODUCT ONLINE TO ACTIVATE YOUR GUARANTEE AT
www.bnthermic.co.uk



IMPORTANT: PLEASE READ THESE INSTRUCTIONS, NOTE THE SAFE OPERATIONAL REQUIREMENTS, WARNINGS, AND CAUTIONS. USE THIS PRODUCT CORRECTLY, AND WITH CARE FOR THE PURPOSE FOR WHICH IT IS INTENDED. FAILURE TO DO SO MAY CAUSE DAMAGE AND/OR PERSONAL INJURY AND WILL INVALIDATE THE WARRANTY.

1. SAFETY INSTRUCTIONS

1.1 ELECTRICAL SAFETY

WARNING! It is the responsibility of the owner and the operator to read, understand and comply with the following:

You must check all electrical products, before use, to ensure that they are safe. You must inspect power cables, plugs, sockets and any other connectors for wear or damage. You must ensure that the risk of electric shock is minimised by the installation of appropriate safety devices. A Residual Current Circuit Breaker (RCCB) should be incorporated in the main distribution board. If in any doubt consult a qualified electrician.

You must also read and understand the following instructions concerning electrical safety.

- The Health & Safety at Work Act 1974 makes owners of electrical appliances responsible for the safe condition of those appliances and the safety of the appliance operators. If in any doubt about electrical safety, contact a qualified electrician.
- Installation should always be carried out by a qualified electrician or a competent person in accordance with current electrical regulation.
- Ensure that the insulation of all the cables on the appliance is undamaged and safe, before connecting it to the power supply.
- Ensure that the cables are always protected against short circuit and overload.
- Regularly inspect the power supply cables and plugs etc. for wear or damage and check all connections to ensure that none are loose.
- Important: Ensure that the voltage marked on the appliance matches the power supply to be used and that a correctly rated fuse is fitted.
- DO NOT use worn or damaged cables, plugs or connectors. Immediately have any faulty item repaired or replaced by a qualified electrician.
- The unit should be protected by a suitably rated isolator and fuse or MCB.
- This air curtain is IP20 rated and is suitable for indoor or under cover use only.
- Do not attach this air curtain to an extension cord it must be hard wired in position.

1.2 GENERAL SAFETY INSTRUCTIONS

- ✓ Remove all packaging and store it away from children, check the package and air curtain for visible damage or tampering.
- ✓ Familiarise yourself with the applications and limitations of the air curtain.
- ✓ Ensure the air curtain is in good order and condition both physically and electrically before use. If in any doubt, do not use the unit and contact your supplier.
- ✓ Only use recommended attachments and parts. To use unauthorised parts may be dangerous and will invalidate your warranty.
- ✓ Keep tools and other items away from the air curtain when it is in use.
- ✓ Keep children and unauthorised persons away from the air curtain, as it gets **hot**.
- ✓ Disconnect from mains and allow to cool before attempting any cleaning or maintenance.
- X **DO NOT** use in areas where hazardous gasses or dusts that may be present.
- X **DO NOT** locate the air curtain directly below the power outlet.
- X **DO NOT** disassemble the air curtain for any reason. This air curtain must be checked by qualified personnel only.
- X **DO NOT** use this air curtain to perform a task for which it has not been designed.
- ❑ **WARNING!** This air curtain is not equipped with a built in device to control the room temperature. Do not use this air curtain in a small room if it is occupied by people not capable of leaving the room on their own, unless constant supervision is provided.
- ❑ **WARNING!** Ensure you observe the safety distances and mounting heights and there is no possibility of inflammable materials coming into contact.



2. INTRODUCTION & SPECIFICATION

This air curtain produces a totally dry heat, no condensation, no gas, no fumes. It reaches maximum heat output within a minute from being turned on. It is quick and easy to install reducing installation costs. Used with the CS-7 controller it can provide low / high heat or fan only settings.

Model	CAD-60
Power	6000W
Input supply	220-240V
Amps	26A
Dimensions (W x D x H)	1105 x 108 x 225mm
Weight	13.5kg
Recommended Mounting Height	2.5 - 3.5M
Safety Distance from Air curtain	1.5M
Optional Controller Model Number	CS-7
Optional Thermostat	RST3-IN
Optional Tamperproof Thermostat	RST3-TP



CS-7
Controller
(Optional Extra)



RST3-IN
Thermostat
(Optional Extra)



RST3-TP
Tamperproof Thermostat
(Optional Extra)

3. LOCATION OF AIR CURTAIN

When mounting above a doorway, the air curtain can be wall or ceiling mounted at a recommended height of 2.5 – 3.5m above floor level and a minimum of 300mm from adjacent walls.

4. MOUNTING INSTALLATION

- ❑ **IMPORTANT!** DO NOT mount air curtain directly below the socket outlet.
- ❑ **IMPORTANT!** Ensure that the mounting surface / ceiling supports are capable of taking the weight of the air curtain.
- ❑ **IMPORTANT!** Do not allow any object to come closer than 1.5m to the air curtain outlet.
- ❑ **IMPORTANT!** Always mount the air curtain horizontal mounting at any other angle will reduce the air curtain's life and invalidate the guarantee.
- ❑ **IMPORTANT!** The air intake and discharge areas must be kept completely clear for a minimum of 1.5m from the front of the air curtain.

4.1 MOUNTING KIT

The mounting kit supplied with each heater consists of the following items.

1 x Backbone / spacer (approximately the same length as the heater).

2 x Backbone right angled brackets.

2 x Small wall mounting brackets, 2 x Large hanging brackets, 2 x Plastic domes

4 x M2.9 Self Tapping Screws, 6 x M5 x 12mm long pozi drive screws, 2 x M5 Lock washers 4 x M4 Nuts and 4 x M4 Washers.

4.2 WALL MOUNTING ABOVE A DOORWAY



Pic 1

Attach the two small wall mounting brackets to the heater using the plastic domes and M2.9 Screws. Make sure both open slots are facing downwards and the brackets face towards the back of the heater (see Pic 1).

Attach the 2 backbone right angled brackets to the backbone using the M4 nuts and washers (see Pic 2)

Securely attach the backbone to the wall using suitable fixings (not supplied) The backbone may be removed once the two end brackets have been securely mounted in position. It is only required to obtain the correct spacing of the Backbone right angled brackets. Partially insert M5 screws into the outer two holes in each end of the bracket. Make sure the screw goes all the way through and the thread is just showing the other side (see Pic 2). The heater with its two end brackets should now be slotted onto the fixing bracket (see Pic 3). Now tighten up the four end screws and add an additional M5 centre screw and lock washer into the centre hole at each end of the fixing bracket (see Pic 4). **UNDER NO CIRCUMSTANCES MUST THE HEATER BE TURNED ON IF THESE TWO CENTRE SCREWS AND LOCK WASHERS ARE NOT PRESENT OR TIGHTENED UP.**

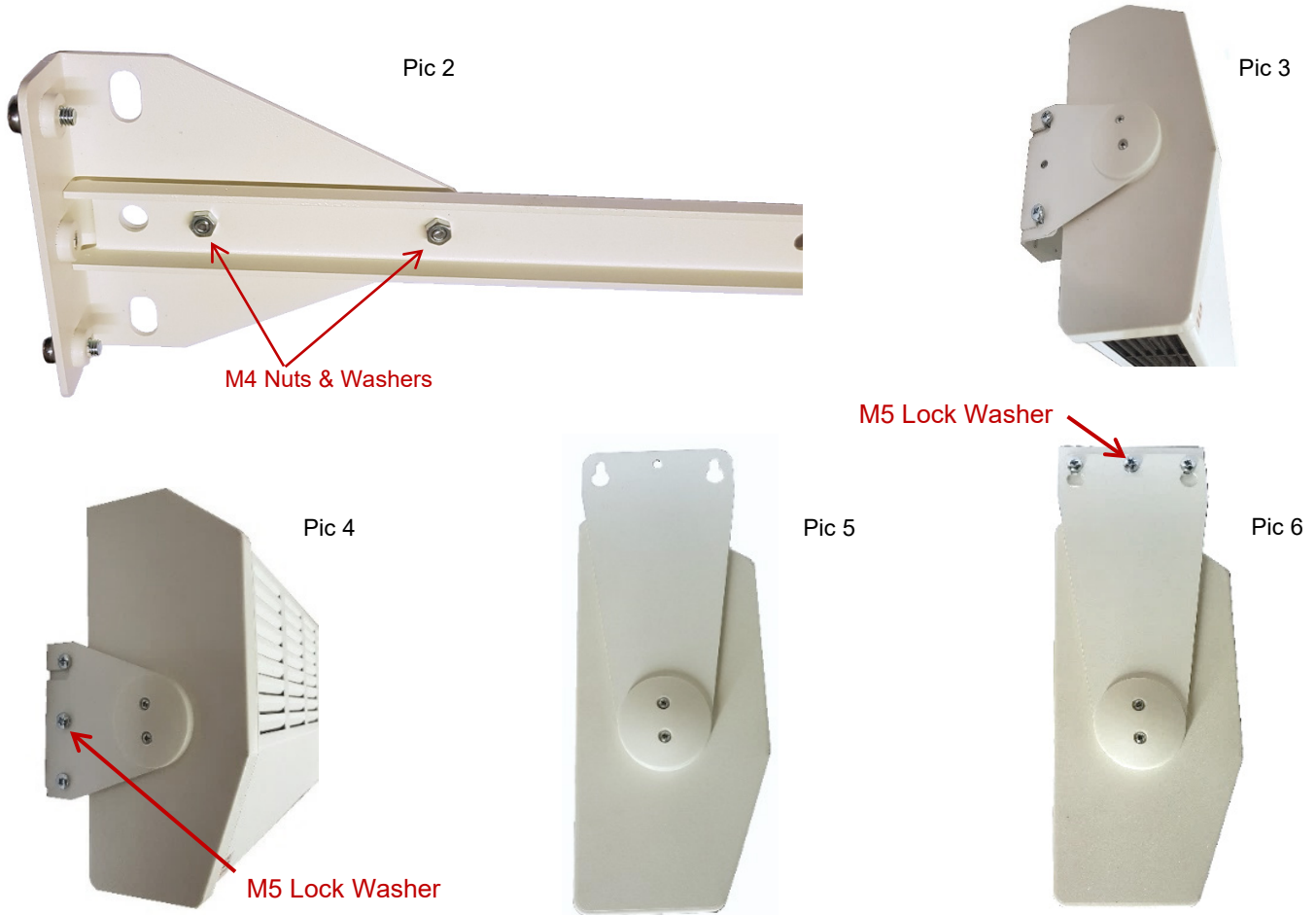

4.3 CEILING MOUNTING ABOVE A DOORWAY USING SUPPLIED BRACKETS OR DROP RODS (not supplied)

You can either use M8 drop rods in the two threaded holes on the top of the heater (drop rods not supplied) or mount directly to the ceiling using the supplied brackets. If mounting using the supplied brackets use the method (section 4.2) with the exception that you use the Large Side Brackets and they must face upwards (see Pic 5). Do not switch on unless the 2 x M5 centre screws and lock washers are fitted to the side brackets and tightened. (see Pic 6)

5. ELECTRICAL CONNECTIONS

5.1 230V SINGLE PHASE – Without controls.

Please make sure you have read the Safety instructions and that you are a suitably qualified electrician before continuing. Drawings show connections inside the black terminal box on the outside of the air curtain. **Do NOT use power tools to undo or do up terminal screws.**

Please Note:- Specified cable sizes are for typical installations, correction factors may need to be used when determining actual cable sizes.

Standard Connection and Use

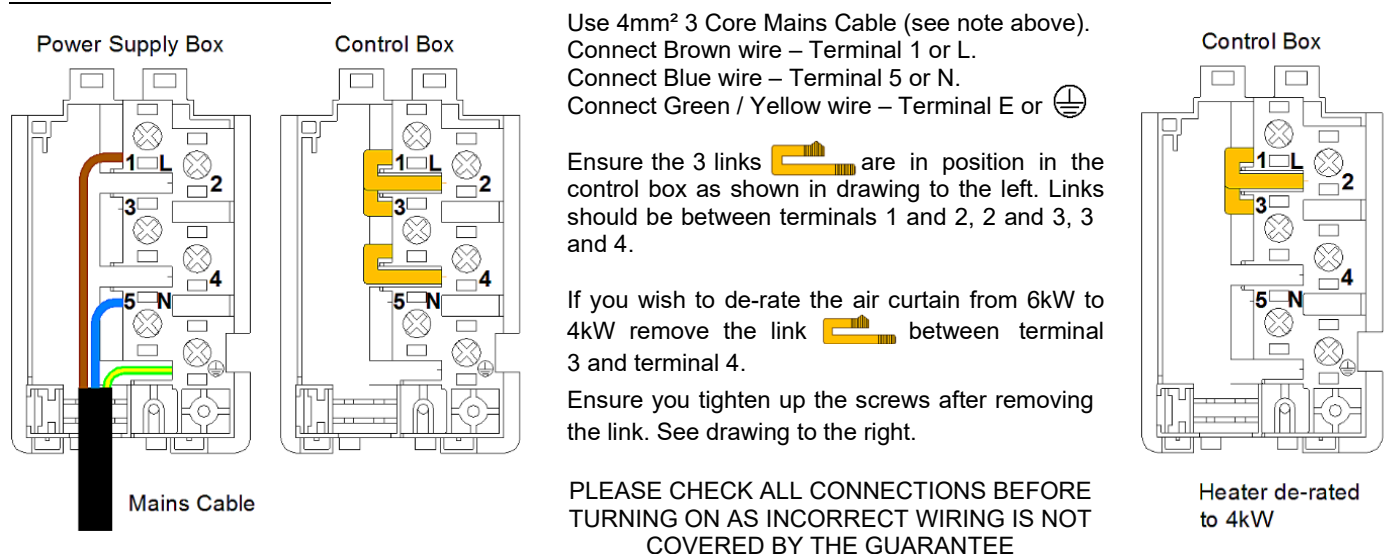

5.2 230V SINGLE PHASE – With Thermostat (RST3-IN or RST3-TP). Fan runs continuously and heat turns on / off with thermostat.
 See Section 5.3 if you want both the fan and heat to turn on and off together.

Please make sure you have read the Safety instructions and that you are a suitably qualified electrician before continuing.
 Drawings show connections inside the black terminal box on the outside of the air curtain and the inside of the RST3-IN or RST3-TP Thermostat.
 Other thermostats may be used BUT they must be suitable for a 10A Load. **Do NOT use power tools to undo or do up terminal screws.**
 Please Note:- Specified cable sizes are for typical installations, correction factors may need to be used when determining actual cable sizes.

Standard Connection using RST3-IN or RST3-TP Thermostat

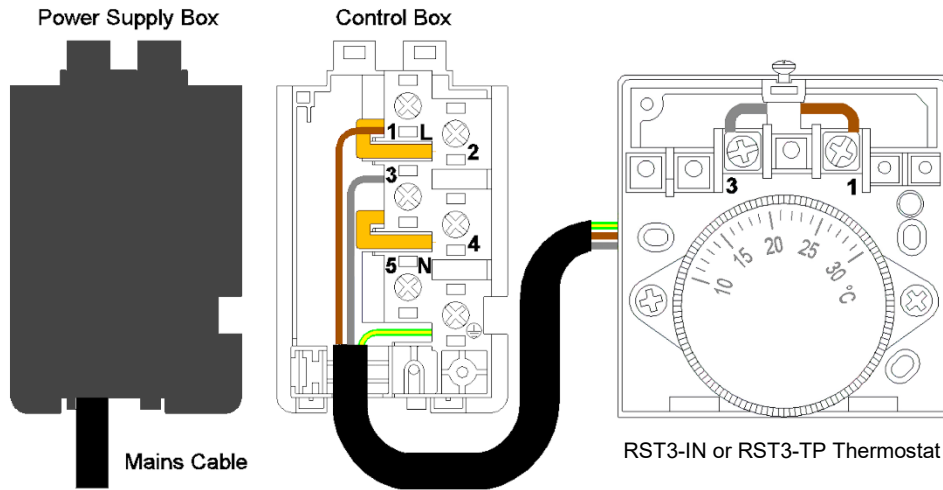

Use 1.5mm² 3 Core Cable to connect the heater to the thermostat (see note above).

Remove link  in heater terminal box between terminals 2 and 3.
 Ensure the remaining 2 links are in position as shown in drawing to the left.

Air curtain to Thermostat Cable – (Colours for reference only)

Connect Brown wire – Terminal 1 or L of air curtain and Terminal 1 of Thermostat.
 Connect Grey wire – Terminal 3 of air curtain and Terminal 3 of Thermostat.
 Connect Green / Yellow wire – Terminal E or  of air curtain and earth connection on Thermostat.

If you wish to de-rate the air curtain from 6kW to 4kW remove the link  between terminal 3 and terminal 4. Ensure you tighten up the screws after removing the link.

PLEASE CHECK ALL CONNECTIONS BEFORE TURNING ON AS INCORRECT WIRING IS NOT COVERED BY THE GUARANTEE

5.3 230V SINGLE PHASE – With Thermostat (RST3-IN or RST3-TP). Both fan and heat turn on / off with thermostat.
 See Section 5.2 if you want the fan to run continuously and only the heat turns on / off with the thermostat.

Please make sure you have read the Safety instructions and that you are a suitably qualified electrician before continuing.
 Drawings show connections inside the black terminal box on the outside of the air curtain and the inside of the RST3-IN or RST3-TP Thermostat.
 Other thermostats may be used BUT they must be suitable for a 10A Load. **Do NOT use power tools to undo or do up terminal screws.**
 Please Note:- Specified cable sizes are for typical installations, correction factors may need to be used when determining actual cable sizes.

Standard Connection using RST3-IN or RST3-TP Thermostat

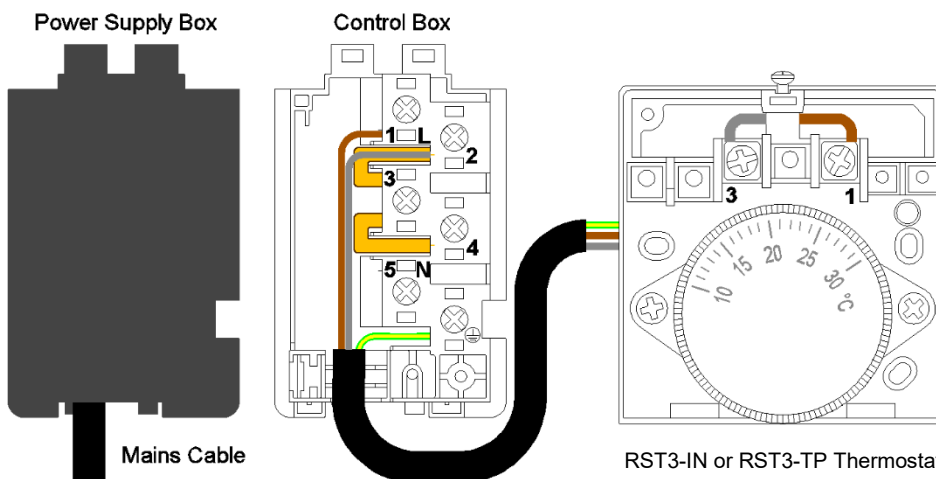

Use 1.5mm² 3 Core Cable to connect the heater to the thermostat (see note above).

Remove link  in heater terminal box between terminals 1 and 2.
 Ensure the remaining 2 links are in position as shown in drawing to the left.

Air curtain to Thermostat Cable – (Colours for reference only)

Connect Brown wire – Terminal 1 or L of air curtain and Terminal 3 of Thermostat.
 Connect Grey wire – Terminal 3 of air curtain and Terminal 1 of Thermostat.
 Connect Green / Yellow wire – Terminal E or  of air curtain and earth connection on Thermostat.

If you wish to de-rate the air curtain from 6kW to 4kW remove the link  between terminal 3 and terminal 4. Ensure you tighten up the screws after removing the link.

PLEASE CHECK ALL CONNECTIONS BEFORE TURNING ON AS INCORRECT WIRING IS NOT COVERED BY THE GUARANTEE

5.4 Adding a Programmable Timer (PROTIM-7). Both fan and heat turn on / off with timer.

Please make sure you have read the Safety instructions and that you are a suitably qualified electrician before continuing. Drawings show connections inside the black terminal box on the outside of the air curtain and the inside of the PROTIM-7 Timer. **Do NOT use power tools to undo or do up terminal screws.**

Please Note:- Specified cable sizes are for typical installations, correction factors may need to be used when determining actual cable sizes.

Standard Connection using a PROTIM-7 Timer.

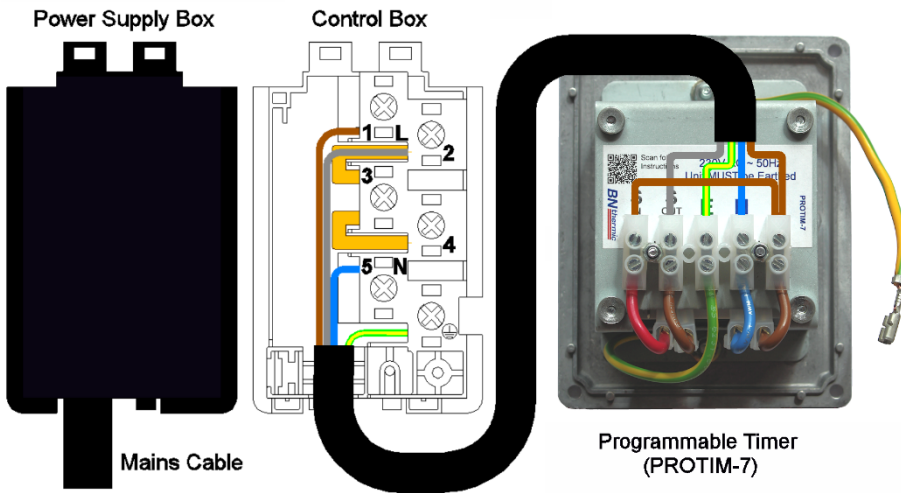

Use 0.75mm² 4 Core Cable to connect the air curtain to the PROTIM-7 Timer (see note above).

Remove link  in air curtain terminal box between terminals 1 and 2. Ensure the remaining 2 links are in position as shown to the left.

Air curtain (Control Box) to PROTIM-7 Timer Cable – (Colours for reference only)

Connect Brown wire – Terminal 1 or L of air curtain and Terminal L on Timer.

Add 0.75mm² Link wire between Terminal L on Timer and Terminal Sin on Timer

Connect Grey wire – Terminal 2 of air curtain and Terminal Sout on Timer.

Connect Blue wire – Terminal 5 or N of air curtain and Terminal N on Timer.

Connect Green / Yellow wire – Terminal E or  of air curtain and earth connection (Terminal E) on Timer.

PLEASE CHECK ALL CONNECTIONS BEFORE TURNING ON AS INCORRECT WIRING IS NOT COVERED BY THE GUARANTEE

5.5 230V SINGLE PHASE – With CS-7 Controller (CS-7 Controller provides on / off / high heat / low heat / fan only settings).

Please make sure you have read the Safety instructions and that you are a suitably qualified electrician before continuing. Drawings show connections inside the black terminal box on the outside of the air curtain and the inside of the CS-7 Controller. **Do NOT use power tools to undo or do up terminal screws.**

Please Note:- Specified cable sizes are for typical installations, correction factors may need to be used when determining actual cable sizes.

Standard Connection using CS-7 Controller

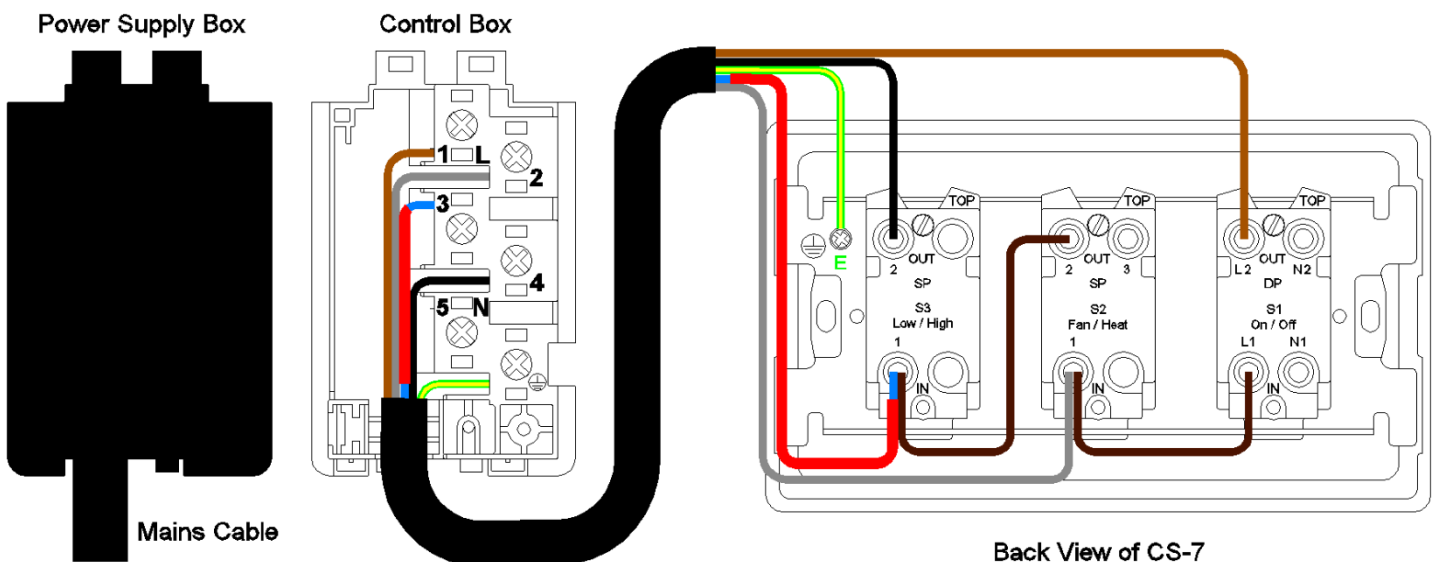

Use 1.5mm² 5 Core Cable to connect the air curtain to the CS-7 Controller (see note above).

Remove any links  that may be present in air curtain terminal box between terminals 1,2,3,4 or 5.

Air curtain to CS-7 Controller Cable – (Colours for reference only)

Connect Brown wire – Terminal 1 or L of air curtain and Top Terminal L2 (Supply) on right DP Switch of CS-7.

Connect Grey wire – Terminal 2 of air curtain and Centre Switch Terminal 1 of CS-7.

Connect Blue wire (adding red or another suitable colour sleeve to both ends first) – Terminal 3 of air curtain and Terminal 1 on Left SP Switch of CS-7.

Connect Black wire – Terminal 4 of air curtain and Terminal 2 on left SP Switch of CS-7.

Connect Green / Yellow wire – Terminal E or  of air curtain and earth connection on CS-7.

PLEASE CHECK ALL CONNECTIONS BEFORE TURNING ON AS INCORRECT WIRING IS NOT COVERED BY THE GUARANTEE

5.6 230V SINGLE PHASE – With CS-7 Controller and RST3-IN or RST3-TP Thermostat. When switched ON fan runs continuously and only heat turns on / off with thermostat. See Section 5.6 if you want both the fan and heat to turn off together.

Please make sure you have read the Safety instructions and that you are a suitably qualified electrician before continuing. Drawings show connections inside the small and large black terminal box on the outside of the air curtain and the inside of the CS-7 and RST-TP Thermostat Controllers. Other thermostats may be used BUT they must be suitable for a 10A load.

Please Note:- Specified cable sizes are for typical installations, correction factors may need to be used when determining actual cable sizes.

Standard Connection using CS-7 Controller and RST3-IN or RST3-TP Thermostat - **Do NOT use power tools to undo or do up terminal screws.**

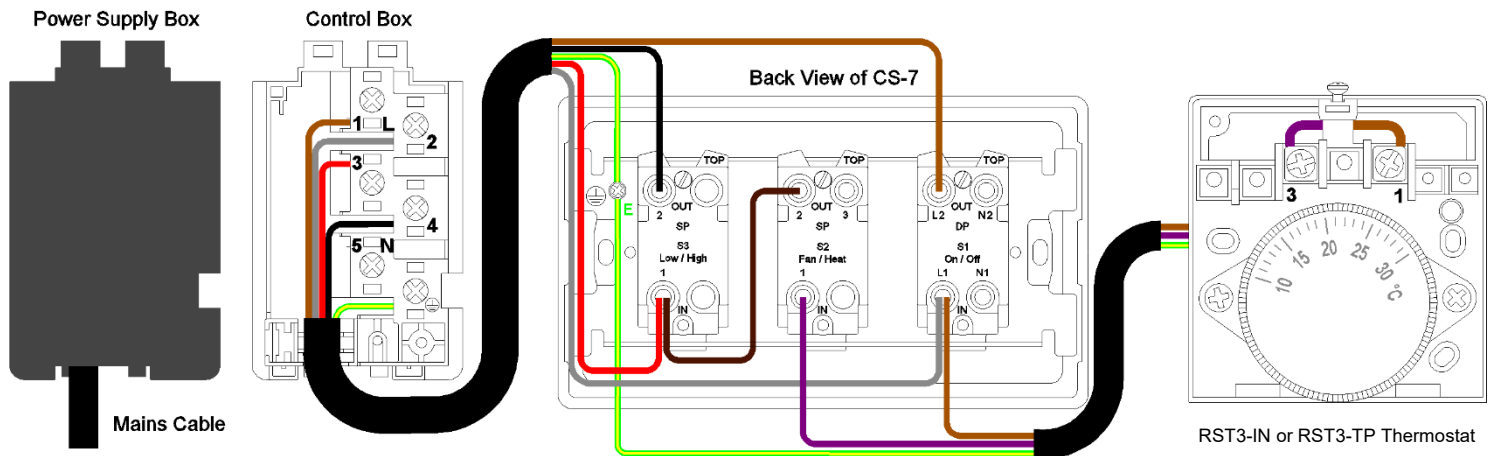

Use 1.5mm² 5 Core Cable to connect the air curtain to the CS-7 Controller (see note above).

Use 1.5mm² 3 Core Cable to connect the CS-7 Controller to Thermostat (see note above).

Remove any links  that may be present in air curtain terminal box between terminals 1,2,3,4 or 5.

Air curtain (Control Box) to CS-7 Controller Cable – (Colours for reference only)

Remove the Dark Brown link cable from the centre switch terminal 1 to the right centre switch terminal L1.

Connect Brown wire – Terminal 1 or L of air curtain and Top Terminal L2 on the right DP Switch of CS-7.

Connect Grey wire – Terminal 2 of air curtain and L1 on right DP Switch of CS-7.

Connect Red wire – Terminal 3 of air curtain and Terminal 1 on Left SP Switch of CS-7.

Connect Black wire – Terminal 4 of air curtain and Terminal 2 on Left SP Switch of CS-7.

Connect Green / Yellow wire – Terminal E or  of air curtain and earth connection on CS-7.

CS-7 Controller to Thermostat Cable – (Colours for reference only)

Connect Brown wire – Bottom Terminal L1 on right DP Switch of CS-7 and Terminal 1 of the Thermostat.

Connect Purple wire – Terminal 1 of middle Switch of CS-7 and Terminal 3 of the Thermostat.

Connect Green / Yellow wire – Terminal E or  of CS-7 and earth connection of the Thermostat.

PLEASE CHECK ALL CONNECTIONS BEFORE TURNING ON AS INCORRECT WIRING IS NOT COVERED BY THE GUARANTEE

5.7 230V SINGLE PHASE – With CS-7 Controller and RST3-IN or RST3-TP Thermostat. When switched ON both the fan and heat turn on / off with thermostat. See Section 5.5 if you want the fan to run continuously and only the heat turns on / off with the thermostat.

Please make sure you have read the Safety instructions and that you are a suitably qualified electrician before continuing. Drawings show connections inside the small and large black terminal box on the outside of the air curtain and the inside of the CS-7 and RST3-IN or RST3-TP Thermostat Controllers. Other thermostats may be used BUT they must be suitable for a 10A load.

Please Note:- Specified cable sizes are for typical installations, correction factors may need to be used when determining actual cable sizes.

Standard Connection using CS-7 Controller and RST3-IN or RST3-TP Thermostat - **Do NOT use power tools to undo or do up terminal screws.**

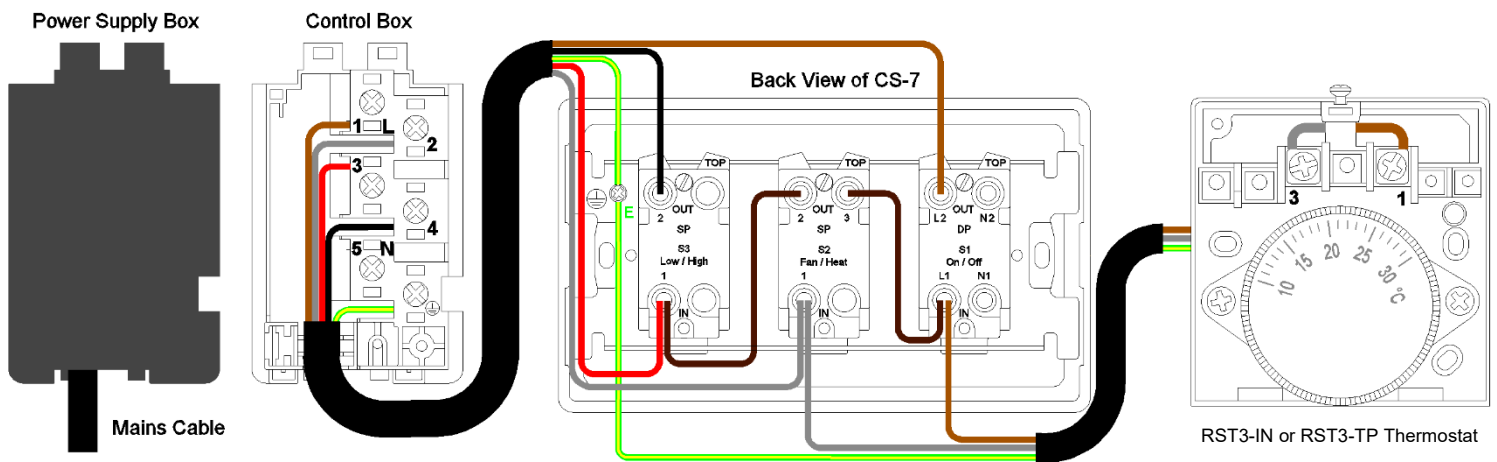

Use 1.5mm² 5 Core Cable to connect the air curtain to the CS-7 Controller (see note above).

Use 1.5mm² 3 Core Cable to connect the CS-7 Controller to Thermostat (see note above).

Remove any links  that may be present in air curtain terminal box between terminals 1,2,3,4 or 5.

Air curtain (Control Box) to CS-7 Controller Cable – (Colours for reference only)

Move the Dark Brown link cable from the centre switch terminal 1 to the centre switch terminal 3 (shown above by dark brown wire).

Connect Brown wire – Terminal 1 or L of air curtain and Top Terminal L2 on the right DP Switch of CS-7.

Connect Grey wire – Terminal 2 of air curtain and Centre Switch Terminal 1 of CS-7.

Connect Red wire – Terminal 3 of air curtain and Terminal 1 on Left SP Switch of CS-7.

Connect Black wire – Terminal 4 of air curtain and Terminal 2 on Left SP Switch of CS-7.

Connect Green / Yellow wire – Terminal E or  of air curtain and earth connection on CS-7.

CS-7 Controller to Thermostat Cable – (Colours for reference only)

Connect Brown wire – Bottom Terminal L1 on right DP Switch of CS-7 and Terminal 1 of the Thermostat.

Connect Grey wire – Terminal 1 of middle Switch of CS-7 and Terminal 3 of the Thermostat.

Connect Green / Yellow wire – Terminal E or  of CS-7 and earth connection of the Thermostat.

PLEASE CHECK ALL CONNECTIONS BEFORE TURNING ON AS INCORRECT WIRING IS NOT COVERED BY THE GUARANTEE

6. MAINTENANCE

Note: Before examining or carrying out any maintenance ensure the air curtain has cooled down and is disconnected from the mains supply.

The air curtains are intended to operate for many years, problem free. All moving parts are factory lubricated and therefore should require no service. Maintenance is limited to keeping both the inlet and outlet areas free from any accumulation of dust or any other foreign materials. This is especially important immediately before the heating season. Any dust build up can be loosened using a brush and a vacuum cleaner applied to the airways to ensure completed removal of any dust. When the air curtain is first turned on after cleaning an unusual odour may be noted this is due to the dust particles which inevitably will be disturbed and will be burnt off from the heating element.

If in any doubt always consult a qualified electrician for advice.

7. AUTO CUT OUT / FUSE REPLACEMENT

This air curtain is fitted with a semi-automatic safety device to prevent overheating. The device will isolate the heating element while the fan continues to operate. Should this occur, disconnect the air curtain from the mains supply for a minimum of 5 minutes, check and remove any foreign materials around the airways. If the air curtain fails to operate or the safety cut out operates again, turn off the air curtain and contact a qualified electrician.

The Heater is protected by a fuse. The fuse holder is located on the front face of the unit. Should the fuse fail, replace with another 12.5A or 12A fuse. If this replacement fuse fails seek professional help.

NOTE: It is our policy to continually improve products and as such we reserve the right to alter data, specifications and component parts without prior notice.



WEEE REGULATIONS:

This appliance bears the symbol of the crossed waste bin. This indicates that, at the end of its useful life, it must not be disposed of as domestic waste, but must be taken to a collection centre for waste electrical and electronic equipment. It is the user's responsibility to dispose of this appliance through the appropriate channels. Failure to do so may incur penalties established by laws governing waste disposal.

IMPORTANT: No liability is accepted for incorrect use of this product.

WARRANTY: Your BN Thermic product is guaranteed for one year from date of purchase. We will repair or replace at our discretion any part found to be defective. We cannot assume any consequential liability. This guarantee in no way prejudices your rights under common law and is offered as an addition to consumer liability rights.

REGISTER: Activate your warranty by registering online at www.bnthermic.co.uk and retain this installation data for future reference.

BN Thermic Ltd,
34 Stephenson Way,
Crawley, RH10 1TN
Tel: 01293 547361
sales@bnthermic.co.uk
www.bnthermic.co.uk

CAD-60INS-v02-1